

INSTRUCTION MANUAL

Sausage Stuffer

Item	46325
Model	SS-ES-0065-C



Warning!

Before you begin using your appliance, **PLEASE READ AND UNDERSTAND THIS DOCUMENT CAREFULLY** before installing, operating, maintaining, or servicing.

There are many important safety messages in this manual and on your appliance. Always read all safety messages.

Failure to do so can result in appliance failure, property damage, serious injury or death. Appliance failure, injury or property damage due to improper installation is not covered by warranty.

Stop!

DO NOT RETURN THIS PRODUCT TO THE STORE!

For questions or assistance with this product, call TRENTO Toll free: **1-833-487-3686** or visit the support section from our website, **www.trentoequipment.com**

Version: Revised - 05/10/2024



TABLE OF CONTENTS

Section	Page
General Information -----	3 - 4
Safety and Warranty -----	4 - 8
Technical Specifications -----	9
Installation -----	9 - 13
Operation -----	13 - 16
Maintenance -----	16 - 21
Troubleshooting -----	22
Parts Breakdown -----	23 - 26
Electrical Schematics -----	27
Notes -----	28 - 30
Warranty Registration -----	31

GENERAL INFORMATION

Omcan Manufacturing and Distributing Company Inc., Food Machinery of America, Inc. dba Omcan and Omcan Inc. are not responsible for any harm or injury caused due to any person's improper or negligent use of this equipment. The product shall only be operated by someone over the age of 18, of sound mind, and not under the influence of any drugs or alcohol, who has been trained in the correct operation of this machine, and is wearing authorized, proper safety clothing. Any modification to the machine voids any warranty, and may cause harm to individuals using the machine or in the vicinity of the machine while in operation.

CHECK PACKAGE UPON ARRIVAL

Upon receipt of an Omcan shipment please inspect for external damage. If no damage is evident on the external packaging, open carton to ensure all ordered items are within the box, and there is no concealed damage to the machine. If the package has suffered rough handling, bumps or damage (visible or concealed), please note it on the bill of lading before accepting the delivery and contact Omcan within 24 hours, so we may initiate a claim with the carrier. A detailed report on the extent of the damage caused to the machine must be filled out within three days, from the delivery date shown in the shipping documents. Omcan has no recourse for damaged products that were shipped collect or third party.

Before operating any equipment, always read and familiarize yourself with all operation and safety instructions.

Omcan would like to thank you for purchasing this machine. It's of the utmost importance to save these instructions for future reference. Also save the original box and packaging for shipping the equipment if servicing or returning of the machine is required.

Omcan Fabrication et distribution Compañie Limité et Food Machinery d'Amérique, dba Omcan et Omcan Inc. ne sont pas responsables de tout dommage ou blessure causé du fait que toute personne ait utilisé cet équipement de façon irrégulière. Le produit ne doit être exploité que par quelqu'un de plus de 18 ans, saine d'esprit, et pas sous l'influence d'une drogue ou d'alcool, qui a été formé pour utiliser cette machine correctement, et est vêtu de vêtements de sécurité approprié. Toute modification de la machine annule toute garantie, et peut causer un préjudice à des personnes utilisant la machine ou des personnes à proximité de la machine pendant son fonctionnement.

VÉRIFIEZ LE COLIS DÈS RÉCEPTION

Dès réception d'une expédition d'Omcan veuillez inspecter pour dommages externes. Si aucun dommage n'est visible sur l'emballage externe, ouvrez le carton afin de s'assurer que tous les éléments commandés sont dans la boîte, et il n'y a aucun dommage dissimulé à la machine. Si le colis n'a subi aucune mauvaises manipulations, de bosses ou de dommages (visible ou cachée), notez-le sur le bond de livraison avant d'accepter la livraison et contactez Omcan dans les 24 heures qui suivent, pour que nous puissions engager une réclamation auprès du transporteur. Un rapport détaillé sur l'étendue des dommages causés à la machine doit être rempli dans un délai de trois jours, à compter de la date de livraison indiquée dans les documents d'expédition. Omcan n'a aucun droit de recours pour les produits endommagés qui ont été expédiées ou cueilli par un tiers transporteur.

Avant d'utiliser n'importe quel équipement, toujours lire et vous familiariser avec toutes les opérations et les

GENERAL INFORMATION

consignes de sécurité.

Omcan voudrais vous remercier d'avoir choisi cette machine. Il est primordial de conserver ces instructions pour une référence ultérieure. Également conservez la boîte originale et l'emballage pour l'expédition de l'équipement si l'entretien ou le retour de la machine est nécessaire.

Omcan Empresa De Fabricacion Y Distribucion Inc. Y Maquinaria De Alimentos De America, Inc. dba Omcan y Omcan Inc. no son responsables de ningun daño o perjuicio causado por cualquier persona inadecuada o el uso descuidado de este equipo. El producto solo podra ser operado por una persona mayor de 18 años, en su sano juicio y no bajo alguna influencia de droga o alcohol, y que este ha sido entrenado en el correcto funcionamiento de esta máquina, y ésta usando ropa apropiada y autorizada. Cualquier modificación a la máquina anula la garantía y puede causar daños a las personas usando la máquina mientras esta en el funcionamiento.

REVISE EL PAQUETE A SU LLEGADA

Tras la recepcion de un envio Omcan favor inspeccionar daños externos. Si no hay daños evidentes en el empaque exterior, Habra el carton para asegurarse que todos los articulos solicitados estén dentro de la caja y no encuentre daños ocultos en la máquina. Si el paquete ha sufrido un manejo de poco cuidado, golpes o daños (visible o oculto) por favor anote en la factura antes de aceptar la entrega y contacte Omcan dentro de las 24 horas, de modo que podamos iniciar una reclamación con la compañía. Un informe detallado sobre los daños causados a la máquina debe ser llenado en el plazo de tres días, desde la fecha de entrega que se muestra en los documentos de envío. Omcan no tiene ningun recurso por productos dañados que se enviaron a recoger por terceros.

Antes de utilizar cualquier equipo, siempre lea y familiarizarse con todas las instrucciones de funcionamiento y seguridad.

Omcan le gustaría darle las gracias por la compra de esta máquina. Es de la mayor importancia para salvar estas instrucciones para futuras consultas. Además, guarda la caja original y el embalaje para el envío del equipo si servicio técnico o devolución de la máquina que se requiere.

SAFETY AND WARRANTY

DEFINITION OF WARNINGS AND SIGNAL WORDS

SAFETY WARNINGS AND SIGNAL WORDS USED IN THIS MANUAL

The safety instructions serve as indications and precautionary measures that must be taken into account or adopted to avoid a dangerous situation.



This is the safety alert symbol. It is used to alert you to personal injury hazards. Obey all safety messages that follow this symbol to avoid possible injury or death.

SAFETY AND WARRANTY

Warnings can be classified according to the severity of the hazardous situation. The classification is based on an assumption of probability of being exposed to a dangerous situation and what could happen in such a case.

There are four kinds of warnings:

 **DANGER** Indicates a hazardous situation which, if not avoided, will result in death or serious injury.

 **WARNING** Indicates a hazardous situation which, if not avoided, could result in death or serious injury.

 **CAUTION** Indicates a hazardous situation which, if not avoided, may result in minor or moderate injury.

 **NOTICE** Is used to address practices not related to personal injury.

IMPORTANT INFORMATION:

 **NOTE:** provides additional information to clarify or simplify a procedure.

SAFETY WARNINGS ATTACHED TO THE MACHINES

The safety symbols warn of special hazards and are placed in the relevant places on the machine. Check warning symbols daily:

- Are all security symbols present?
- Are all safety symbols recognizable and readable?

Ensure that the safety plates / adhesives are firmly attached to the machine, are easily readable and are not erased during the cleaning process. Disconnect the machine and secure the main switch against reconnection if a warning symbol is missing or no longer recognizable. Do not reconnect the machine until they are in place and all safety symbols are recognizable. If they become damaged or lost, contact your authorized dealer.

INTENDED USE OF THE MACHINE

In general, the hydraulic piston fillers/stuffers are used to prepare sausages made of minced meat. Other applications include dough or paste of any type that can flow through a nozzle/horn of Ø10mm. Never use hard masses or pastes that do not flow and could cause dangerous overpressure. The temperature of the dough to be stuffed should be higher than 2°C (35°F). Do not process frozen or semi-frozen doughs. Working environment conditions: temperature +5 to + 40°C (+40 to + 100°F), relative humidity: 20 to 90%. The maximum operating pressure must not exceed 120 bar.

Any other use would conflict with the machine's characteristics, the manufacturer is not liable for any damages that may occur as a result of improper use.

MODIFICATIONS

DISCLAIMER OF LIABILITY

It is not allowed to modify the machine without the prior express authorization of Trento, neither in its design nor in its security systems. Trento will not be liable for damages caused by arbitrary changes. When a user

SAFETY AND WARRANTY

makes essential modifications to the machine, he assumes the manufacturer status. In such a case, he shall be obliged to take all the measures incumbent on it legally as a manufacturer. The original manufacturer is therefore released from its responsibility.

GENUINE PARTS

The machine is only allowed to be used with original Trento accessories and spare parts. Trento will not be liable for damages caused by using tools, accessories or spare parts from other manufacturers.

IMPORTANT WARNINGS

Since the WARNINGS, CAUTIONS and INSTRUCTIONS in this manual cannot address all possible conditions and situations that may arise, the operator **MUST ALWAYS** exercise common sense and due caution when using this machine!

- DO NOT DISCARD THIS MANUAL; KEEP IT FOR FUTURE REFERENCE BY ALL USERS AND MAINTENANCE PERSONNEL. PLEASE THOROUGHLY READ AND FULLY UNDERSTAND ALL THE INSTRUCTIONS BEFORE SERVICING OR USING THE MACHINE.
- THIS MACHINE HAS MOVING PARTS AND USES VOLTAGES THAT ARE POTENTIALLY HAZARDOUS. FAILURE TO FOLLOW THE INSTRUCTIONS CONTAINED IN THIS MANUAL COULD RESULT IN SEVERE, POSSIBLY LIFE-THREATENING, PERSONAL INJURY.
- THIS MACHINE HAS BEEN DESIGNED EXCLUSIVELY FOR MEAT PROCESSING. USE OF THIS MACHINE FOR ANYTHING OTHER THAN MEAT PROCESSING DOES NOT CONFORM TO ITS INTENDED FUNCTION, IS STRICTLY PROHIBITED AND SHALL VOID TRENTO'S WARRANTY. TRENTO ASSUMES NO RESPONSIBILITY FOR ANY DAMAGE OR INJURY RESULTING FROM IMPROPER USE OF THIS MACHINE.
- DO NOT ALTER OR MODIFY THE MACHINE'S ORIGINAL DESIGN IN ANY WAY; DOING SO WILL VOID TRENTO'S WARRANTY AND MAY RESULT IN PERSONAL INJURY OR DAMAGE TO THE MACHINE.
- This machine **MUST** be installed **ONLY** by a qualified electrician in accordance with the instructions in this manual and in compliance with all applicable national, regional and local electrical, safety and hygiene standards and codes. Compliance with said standards and codes is the sole responsibility of the owner and installer.
- DO NOT open the machine or tamper with its internal parts; none of the internal components requires adjustment or maintenance by the user.
- DO NOT tamper with the machine's mechanical or electrical safeguards.
- Use **ONLY** genuine Trento parts or accessories and have them installed only by a qualified technician. Use of unapproved parts and accessories voids Trento's warranty and may result in personal injury or damage to the machine.
- NEVER attempt to repair the machine on your own. Should the machine require service, contact the authorized dealer from whom you purchased the machine.
- Modifications to the machine that raise noise emission levels above 85 dB(A) may result in hearing damage. ALWAYS wear appropriate hearing protection.

OPERATING HAZARDS

- PLEASE READ THIS MANUAL CAREFULLY AND FULLY UNDERSTAND ALL THE INSTRUCTIONS BEFORE USING THE MACHINE.

SAFETY AND WARRANTY

- DO NOT OPERATE THE MACHINE WITHOUT HAVING FIRST BEEN INSTRUCTED ON ITS USE, MAINTENANCE AND SAFEGUARDS FROM AN EXPERIENCED OPERATOR.
- ALWAYS keep hands and hair away from moving parts when the machine is in use. There is the danger of crushing hands, fingers, etc. when closing the lid or when the piston is raised while the lid is not completely open.
- NEVER wear loose clothing or jewelry that could get caught on moving parts when the machine is in use.
- DO NOT use the machine without wearing the protective gear required by law.
- DO NOT leave the machine unattended while it is switched on or plugged to an electrical outlet. ALWAYS unplug the machine when it is not in use.
- ALWAYS keep your work area well-lit and free of obstacles.
- ALWAYS keep children, visitors and bystanders away from the machine while it is in use or plugged to an electrical outlet. NEVER allow children to operate the machine.
- SHOULD THE MACHINE MALFUNCTION, PROMPTLY TURN IT OFF AND NOTIFY THE APPROPRIATE PERSONNEL.
- ALWAYS follow the hygiene and cleaning instructions in this manual and the local sanitary codes in order to avoid contaminating the food mixture.
- ALWAYS firmly grip both the transport handle (located at the machine's base) and the lid handle when moving the machine. DO NOT tilt the machine too far while it is balanced on its wheels since it is heavy and there is a risk of personal injury or property damage if it tips over.

ELECTRICAL HAZARDS

- DO NOT TAMPER WITH THE MACHINE'S ELECTRIC SYSTEM. THIS MACHINE MUST BE INSTALLED ONLY BY A QUALIFIED ELECTRICIAN AND IN COMPLIANCE WITH APPLICABLE NATIONAL, REGIONAL AND LOCAL ELECTRICAL CODES.
- ALWAYS USE CAUTION WHEN WORKING ON THE MACHINE'S ELECTRICAL SYSTEM SINCE THERE IS A RISK OF ELECTRIC SHOCK DUE TO:
 - DIRECT OR INDIRECT CONTACT WITH ELECTRIC CURRENT.
 - IMPROPERLY INSTALLED DEFECTIVE OR DAMAGED ELECTRICAL PARTS.
- BEFORE operating the machine, make sure that all phases are connected properly and that the machine is properly grounded and/or connected to a circuit leakage breaker and thermal switch. Failure to do so could result in electric shock!
- DO NOT tamper with the machine's electrical wiring or components after installation.
- ALWAYS disconnect the machine from the electrical outlet before proceeding with cleaning, maintenance, or repairs.
- To avoid damaging the power cord and possible injury, keep it away from areas where it may be stepped on or tripped over. DO NOT pull on the power cord to disconnect the plug from the electrical outlet; always pull on the plug.

DISPOSAL

Risk of damage to people and environmental hazards. The machine is composed of different materials. Observe local regulations on waste disposal. Instruct an authorized waste disposal company to dispose of waste correctly.

SAFETY AND WARRANTY

RESIDENTIAL USERS: Vendor assumes no liability for parts or labor coverage for component failure or other damages resulting from installation in non-commercial or residential applications. The right is reserved to deny shipment for residential usage; if this occurs, you will be notified as soon as possible.

1 YEAR PARTS AND LABOR WARRANTY

Within the warranty period, contact Trento Inc. at 1-800-465-0234 to schedule an Trento authorized service technician to repair the equipment locally.

Unauthorized maintenance will void the warranty. Warranty covers electrical and part failures, not improper use.

Please see <https://omcan.com/disclaimer> for complete info.

WARNING:

The packaging components are classified as normal solid urban waste and can therefore be disposed of without difficulty.

In any case, for suitable recycling, we suggest disposing of the products separately (differentiated waste) according to the current norms.

DO NOT DISCARD ANY PACKAGING MATERIALS IN THE ENVIRONMENT!

TECHNICAL SPECIFICATIONS

Model	SS-ES-0065-C
Item Number	46325
Power	1.5 HP / 1.1 kW
Current	5.6A
Barrel Capacity	35 L / 9.2 Gal
Approx. Meat Capacity	65 lbs. / 28 kgs.
Operating Temperature	5 - 40°C / 40 - 100°F
Operating Relative Humidity	20% - 90%
Electrical	208V / 60Hz / 3
Weight	350 lbs. / 160 kgs.
Packaging Weight	400 lbs. / 180 kgs.
Dimensions	23" x 31" x 49" / 570 x 787 x 1245mm
Packaging Dimensions	21" x 27" x 54" / 530 x 680 x 1370mm

INSTALLATION

STORAGE, DELIVERY AND UNPACKING

- ALWAYS keep the machine upright, even while in its packaging.
- NEVER stack machines even if they are in their original packaging.
- NEVER place heavy objects on top of the machines or its packaging.

The machine is delivered on a pallet protected by cardboard packaging. We use only recyclable packaging and ask that you please recycle these materials.

Remove the packaging and thoroughly inspect the machine upon delivery. Should you note any damage to the machine, retain all packing materials and promptly notify the carrier. The transport company is solely responsible for any damage to the machine during transit. If the machine is found to be in satisfactory condition, follow the instructions in POSITIONING THE MACHINE in order to safely convey it to a suitable work area. Your needs will determine the most appropriate location for the machine.

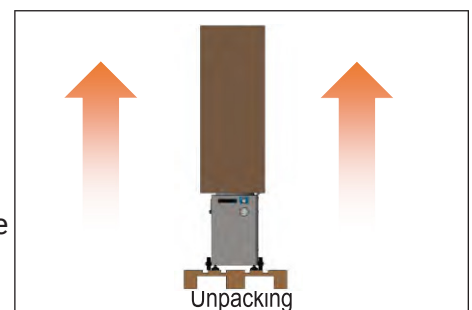

INSTALLATION

PLACEMENT

⚠ DANGER

ELECTRICAL HAZARD!

- The electrical installation of the enclosure must provide a thermal protection device (MCB) and leakage (differential), conforming to the specifications of each machine. A qualified electrician must adjust these safety devices to the specifications of your particular machine.
- Do not use the machine in wet locations.

⚠ CAUTION

- Do not lift the machine more than necessary, it could collapse.

The machine should be placed in the most appropriate place, according to the demands and needs of use. For a good, prolonged operation, the machine should be placed in a sufficiently ventilated area, avoiding lack of air circulation. The workplace should be clean, free from obstacles and have a horizontal and anti-slip surface. Observe a passage area around the machine of 1 meter to proceed to use, clean and maintenance thereof. To move the machine to the desired location:

- ALWAYS firmly hold the carrying handle and the lid handle to move the machine. NEVER use the knee lever to move the machine!
- Tilt the machine so that it is balanced on its wheels and may be rolled into place.
- ALWAYS place the machine on a flat, level surface. Should the machine wobble, adjust the anti-vibration legs until it is perfectly level and stable.
- The machine should be positioned so that the power plug is easily accessible to the operator.



NOTICE

Do not store the machine in cold places (i.e. refrigerated cold room). Persistent low temperatures can cause damages in the machine.

INSTALLATION

INSTALLATION OF THE LID LOCK NUTS AND KNEE LEVER

Before using the stuffer it is necessary to assemble the lid lock nuts and knee lever delivered with the machine.

- Screw the lid lock nuts on the threads projecting from the lid. Do not overtighten, as this would hinder the opening and closing of the lid.
- Place the knee lever at the anchor point.
- Attach the two screws with Allen wrench supplied with the machine. Check the operation of the knee lever. It should move with little effort and return to the center position when released (in the lifting drive the piston).
- Place the two gray caps on the heads of the screws.

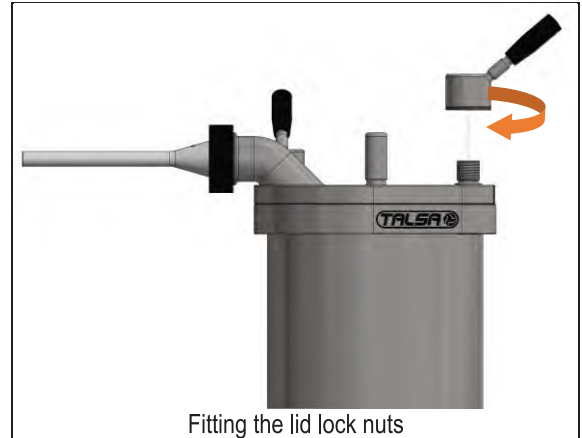

Knee lever position and action of the piston:

- When you push the toggle to the left, the piston must rise. The knee lever automatically returns to the center position when no pressure is applied thereon.
- When pushing the lever rightward the piston must descend. In this position, the lever is automatically locked until the piston reaches the lower position. The piston can be stopped at any time by pushing the lever to the center position.

It is possible to reverse the direction of drive knee lever / piston. Consult your dealer where you purchased the stuffer.

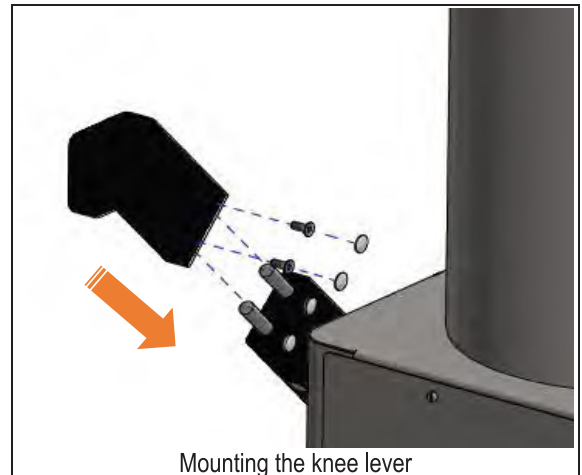

INSTALLING CASTERS

⚠ CAUTION

- To lay down and lift the machine at least two people are needed.
- ALWAYS secure the position of the machine setting the brakes on the castors (optional).

Optionally the stuffer is provided with two pivoting wheels with brakes that facilitate the movement of the stuffer. To install these wheels follow the instructions below:

- Unscrew and remove the screws that hold the panel to the machine base, then withdraw it.
- Remove the evaporator cap (red) and replace it with the transport cap (yellow). This cap closes the oil reservoir hermetically, avoiding leakage of hydraulic oil for the following steps.

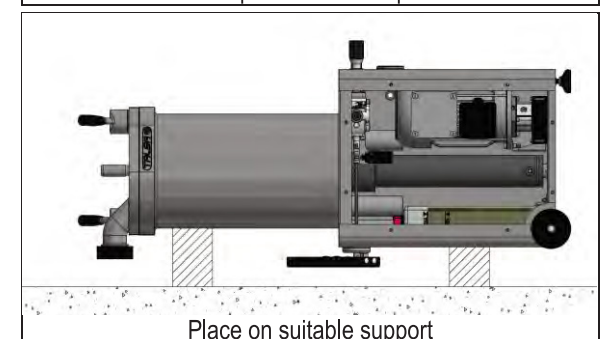
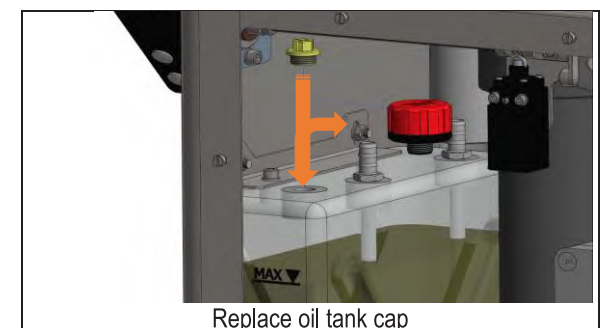

INSTALLATION

- Lay the machine to the side of the knee lever, on a suitable support to prevent damaging the lever. To lay down and lift the machine at least two people are needed.
- Remove the anti-vibratory rubber feet unscrewing them from the machine body.
- Attach the extensions and casters with the screw and washers provided.
- Lift the machine (at least two people are required).
- Very important! Before operating the machine, replace the evaporator cap (red) in the oil tank.
- Check the operation of the machine and close machine body cover.

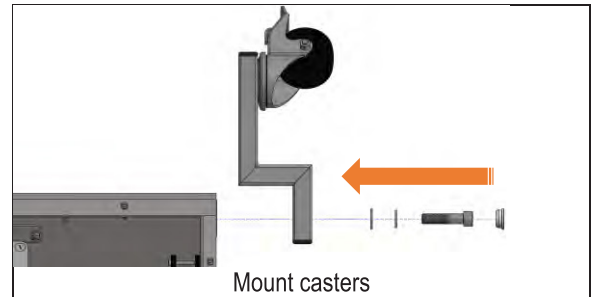
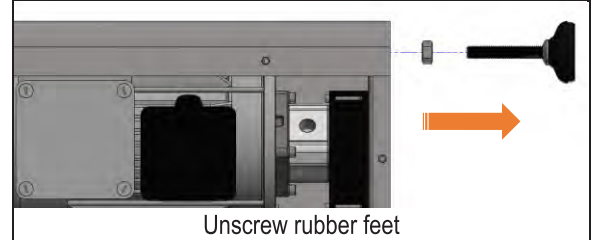

NOTICE

Before putting the machine into operation, make sure to replace the transport cap (yellow) with the cap of the oil tank (red). Operating the machine with the yellow transport cap will damage the hydraulic system!

TRANSPORT CAP OF THE OIL TANK (MACHINES SENT LYING)

Machines sent lying on a pallet (air shipment), have a transport oil cap (yellow) closing the oil tank hermetically, to prevent oil leakage during transport. Before operating the machine, replace the transport oil cap by the depressurized oil cap (red) delivered with the machine.

- Unscrew and remove the screws that hold the panel to the machine base, then withdraw it.
- On the oil reservoir, replace the transport oil cap (yellow) by the depressurized oil cap (red).
- Check the oil level in the tank. It must be between the MAX and MIN marks on the tank. If necessary, add enough oil to bring the level up to the maximum mark. Do not fill the tank completely, as a certain volume of air for expansion of the oil is necessary.
- Replace the panel at the end of operations.

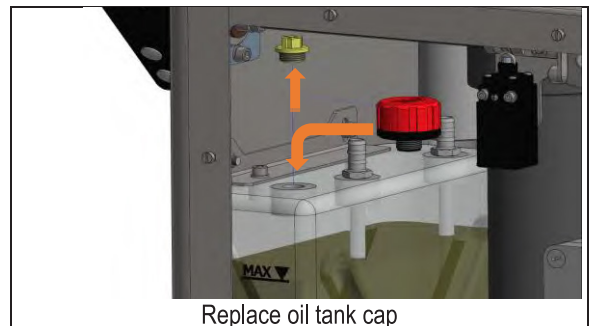

NOTICE

- Before putting the machine into operation, make sure to replace the transport cap (yellow) with the cap of the oil tank (red). Operating the machine with the yellow transport cap will damage the hydraulic system!
- The fillers are supplied from factory with the appropriate hydraulic oil level. Therefore, it is usually not necessary to refill it. In the exceptional event that the new machine is delivered with a lack of hydraulic oil, DO NOT connect it. Proceed to fill it before operation.

INSTALLATION

CONNECTING TO THE POWER SOURCE

⚠ DANGER

ELECTRICAL HAZARD!

- This machine must be installed only by a qualified technician and in compliance with applicable national, regional and local electrical codes.
- The machine **MUST** remain disconnected from the power supply throughout this procedure.

CHECK THE WIRING BEFORE CONNECTING THE MACHINE! Call a qualified electrician if the electrical specifications do not correspond with your power source: the wiring in the electrical cord is normally assigned as follows: PHASE(S): Black, Brown or Gray. NEUTRAL: Blue (or White in some non CE/CEN/UE countries). GROUND: Bi-coloured Yellow / Green (or Green in some non CE/CEN/UE countries).

- Ensure that the electrical characteristics of the stuffer, detailed in the plate fixed to the machine (voltage, frequency, Hz, phases), coincide with those of the mains. A tolerance of $\pm 10\%$ in voltage and frequency $\pm 2\%$ is accepted.
- If they match those of the network, have a qualified electrician connect a plug to the power cord.
- If the voltage of the machine does not match the network, and if dual voltage three-phase motor, it appropriate to adjust the voltage thereof, as described in Voltage change and then have a qualified electrician connect a plug to the power cord.
- It is mandatory the use of a standard plug for connecting the machine.

Once connected machine check the proper operation of the stuffer: push the brace firmly to the left (rising piston).

NOTICE

- If the phases are correctly connected, the piston will rise and lower correctly when operating the knee lever.
- If the phases are not well connected, the pump will operate in reverse, the motor will make noise but the piston will not move. Stop the machine immediately and switch it from the mains. Have a qualified technician permute two of the three phases in the plug; NEVER inside the machine.

OPERATION

NOTICE

- BEFORE STARTING WORK, PLEASE READ AND UNDERSTAND THIS ENTIRE MANUAL AND SAFETY.
- DO NOT use the machine without having been instructed by an advanced user.
- Practice using the machine in vacuum before contacting mass.
- This machine is not designed to run in continuous operation uninterrupted at high pressures, but intermittent operation stops dissipating the heat generated varies depending on the consistency of the product.

OPERATION

STEPS TO FOLLOW

⚠ CAUTION

- If the phases are not well connected, power up the pump will operate in reverse, the engine make noise but will not move the piston. In this case stop immediately and disconnect the machine from the mains.
- Have a qualified electrician permute two of the three phases in the plug.

⚠ WARNING

- Observe all hygiene measures in food processing, using the necessary protection material (washing, gloves, hat, apron, etc.)
1. Fully open the lid. Reduce friction by unscrewing the lid locking nuts.
 2. Before the first use, and regularly thereafter, wash the tank, lid and nozzles/horns with hot water.
 3. Decrease working pressure of the machine to minimum, by turning the pressure valve knob to the left (counter-clockwise).
 4. Plug the machine to the mains.
 5. Lower the piston pushing the knee lever to the right up to the required volume to accommodate the desired meat mass.
 6. Place meat dough in the tank while pressing each load to prevent the presence of air pockets that can break the casing in the working process.
 7. Place the lid seal in its housing with the lip upwards. The lid seal has a unique position with the protruding lip upwards.
Remember: Do not close the lid without the gasket or mounted backwards, because doing so would harm the gasket or lid.
 8. Raise the piston using the knee lever until the mass reaches the top of the tank.
 9. Lubricate with edible fat, or other USDA approved for food, the top of the lid seal and the bottom of the lid.
 10. Close the lid gently. Be careful not to pinch your hand in the closing process.
Important: Do not use the nozzle/horn to close the cover, as it could be twisted; exclusively use the lever for opening and closing lid.
Tighten the lid lock nuts close enough so the pressure cannot raise the lid.
 11. Attach the appropriate nozzle/horn (as wide and short as possible) to the nozzle/horn holder on the lid, securing it with the nozzle/horn nut.
 12. Prepare enough casings.
 13. Press the leg against the knee lever up to its limit. It is not recommended to use the knee lever only halfway as an accelerator, always push it until its limit.
 14. Cautiously increase the working pressure by slowly rotating pressure valve knob clockwise (in the direction

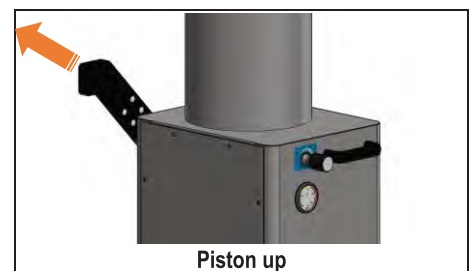
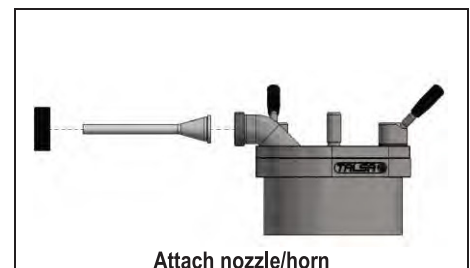
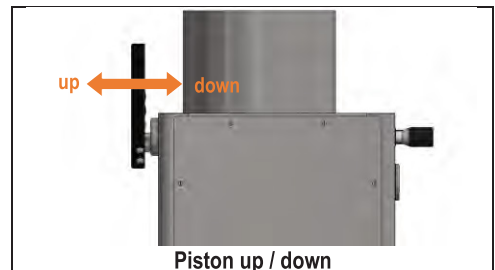
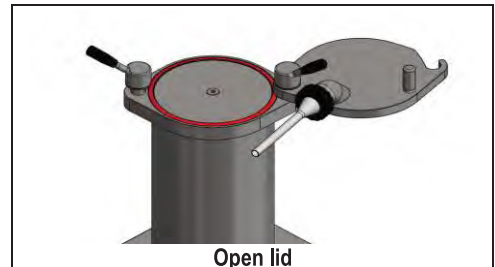

OPERATION

of clock). Avoid high pressure, as it may be excessive and the meat would practically spurt out of the nozzle/horn.

15. When meat mass starts to gush out of the nozzle/horn, reduce the pressure and place the casings. Adjust the pressure to the ideal speed.

Remember: The air trapped between the meat mass and the lid will be expelled first through the nozzle/horn before the mass begins to flow.

16. Once the work is finished, push the knee lever to the right. It is not necessary to keep pushing the lever, since the machine has an automatic lock until the piston reaches the lower position. To stop the hydraulic unit at any time, leave the knee lever at the center position.

17. When finished using the machine, proceed to clean it thoroughly. Always turn down the piston to the bottom of the tank, disconnect the electric plug from the base and make sure the machine's brakes are tightened, thus avoiding any involuntary displacement in your absence.

Remember: clean the filler according to the instructions on the cleaning section when finished using the machine at the end of the day.



⚠ CAUTION

- DO NOT leave the machine unattended while it is powered on or in operation.
- ALWAYS firmly grip both the transport handle (located at the machine's base) and the lid handle when moving the machine. DO NOT tilt the machine too far while it is balanced on its wheels since it is heavy and there is a risk of personal injury or property damage if it tips over).
- ALWAYS keep hands away from any moving parts while the machine is in operation. There is the danger of crushing hands, fingers, etc. when closing the lid or when the piston is raised while the lid is not completely open.
- To prevent mechanical hazards and personal injury, do not open or close the cover if the machine is operating.
- Be careful when removing the lid. Because of its weight it could fall and cause injury.

USEFUL TIPS

- The minimum operating temperature for the filler is 5°C. Therefore never store the machine in cold rooms, freezers, etc.
- This machine is not designed to operate in continuous uninterrupted service, but to work on an intermittent regime with stops to dissipate the heat generated which varies depending on product consistency.
- Given the pressure transmitted to pump hydraulic oil, it is normal that the temperature can raise above 60°C and the machine body is hot after a prolonged operating period.
- For a better presentation of the sausage filling process, smoother and less effort and heating of the machine the following is recommend:
 - Select nozzle/horn with the largest diameter and shortest length possible.
 - Meat mass should be minced/chopped as fine as possible and as warm as possible.
- During operation of the machine with dough, you cannot open the lid until lowering the piston a bit, since the compressed meat mass would prevent it.
- Approach the filler to the worktable as much as possible to avoid meat falling to the ground or on the operator.

OPERATION

- Try to work at a reasonable speed and pressure, thus avoiding constant starts and stops the hydraulic unit.

MAINTENANCE

CLEANING INSTRUCTIONS

NOTICE

- If using detergents, disinfectants or oils maintenance, observe the special instructions of the manufacturers.
- NEVER use water pressure jet to clean or rinse any part of the machine.
- NO use abrasive products, especially those erasable plates or safety adhesives.
- NO open or close the lid without the red seal, because doing so will scratch the cover and flange.
- To prevent mechanical hazards during cleaning operations and removing the piston, always open the lid completely before making up the piston.

⚠ DANGER

Electrical Hazard!

- The machine MUST remain disconnected from the power supply throughout the entire cleaning procedure.
- NEVER wet or dampen the machine's electrical components (switches, cables, etc.)

⚠ CAUTION

- To proceed with the manual cleaning using suitable protection (latex gloves, plastic apron, etc.) is required.
- ALWAYS necessary intensive rinsing machine after application of detergents or disinfectants to prevent contamination of the mass.

Cleaning the filler is essential not only for health reasons but also for efficient operation. NEGLIGENCE IN CLEANING MAY VOID THE WARRANTY. Stuffer should be cleaned after and, where appropriate, before each use. To facilitate this, Trento has designed these machines so that all components are easily accessible.

EXTERIOR CLEANING

- To clean the exterior of the machine use hot water and a mild detergent.
- After each day the bottom of the lid (mass outlet hole), the nozzle/horn holder nut and the nozzles/horns must be thoroughly cleaned, inside with a tubular round brush.
- Use plenty of hot water to clarify the axis of rotation of the lid in order to remove residual salt and spices that might crystallize and swell after a few hours / days of inactivity and prevent the lid is opened and closed easily.
- The top of the piston silicone gasket should also be cleaned daily by following these steps:

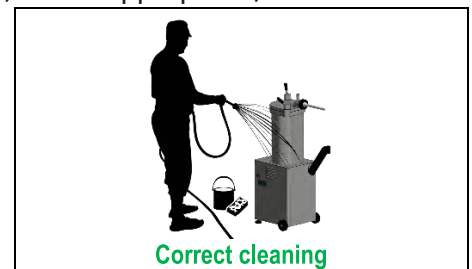

MAINTENANCE

- Fully open the lid and remove the lid gasket.
- Press the knee lever until the piston reaches the top of its travel. A portion of the piston silicone gasket will hover at the top of the tank.
- Clean with a soft brush and / or damp cloth.

CAUTION

- The lid and piston of the filler are heavy as they are made of solid stainless steel. Be careful when removing them.
- Due to their heavy weight, it is recommended to remove the lid and piston between two people.

INTERIOR CLEANING

It is recommended to periodically clean the inside of piston and tank. The frequency depends on the product (dough consistency), working pressure, etc. We recommend starting with a daily inspection, lengthening intervals depending on their needs.

- Fully open the lid and remove the gasket.
- Press the knee until the piston reaches the top of its travel.
- The piston being at the top and simultaneously pushing the knee lever, unscrew the screw located in the center of the piston with the aid of the extractor key supplied with the machine.
- Press the knee lever so that the piston goes down a little.
- Screw the extractor key into the thread of the piston, then press the knee lever to raise the piston.
- Pull up the key to take the piston out of the machine.
- Disconnect the machine.
- Proceed to clean the tank, perfectly drying the bottom in order to avoid the formation of water pockets and subsequent oxidation of the top of the machine body. The hole at the bottom of the tank is a for water drainage.
- Clean the piston and silicone gasket.
- To prevent noise on the rise or lowering of the piston, lubricate the piston silicone gasket before inserting it into the reservoir, with edible fat or other authorized USDA food.
- To mount the piston:
 - Perfectly dry the bottom of the tank.
 - Place the piston in the reservoir and fully tighten the piston screw, taking care that the small seal is installed correctly.
 - Then raise and lower the piston and then tighten the screw to ensure that it is secure. Otherwise it could bend when pushed against the lid.
 - Lubricate the piston screw and thread before placing it. This will make disassembly easier.
- When the machine is not in use, keep the piston at the bottom of the tank. Being immersed in the hydraulic oil will prolong the life of the rod and seals.

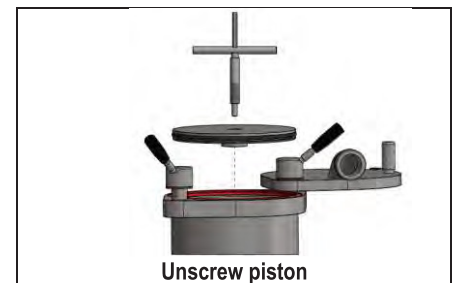

MAINTENANCE

INSTALLING THE PISTON AFTER CLEANING

1. Push knee and place hydraulic ram totally up, to the top.
2. Install the stainless steel piston and tighten hex screw first time with the tool provided.
3. Pull knee and move hydraulically piston down a little and then push knee again, 2nd time, until the piston arrives totally at the top again.
4. Maintaining hydraulic pressure with the black knee pad pushed, tighten piston hex screw again for the 2nd time, this ensures locking and avoid piston movements that can cause damage to the welding.

GENERAL CLEANING RECOMMENDATIONS

Steps	Products	Tools	Observations
Superficial cleaning & residue removal.		Spatula.	Promptly after use.
Extensive cleaning.	Mild detergent.	Brush, bucket.	Allow the product to work approximately 15 minutes.
Rinsing.	Warm water.	Sponge, bucket.	The water should be 40 to 50°C (100 to 120°F).
Inspection.			Visually examine all critical components, especially those subject to stress and wear.
Disinfecting.	Disinfectants; NEVER use bleach.	Sponge, cleaning cloth.	Disinfect after completing all other cleaning operations.
Rinsing.	Potable water.	Sponge, bucket.	ALWAYS rinse the machine thoroughly after using detergents and disinfectants.
Drying.		Cleaning cloth.	Be sure to completely dry all cleaned components.
Conservation.	Lubricating oil.	Cleaning cloth.	Only external machine parts.

MAINTENANCE

RECOMMENDED CLEANING INTERVALS

Interval	Area to be cleaned	Product	Tools	Observations
Daily.	Daily Lid, lid gasket, tank and piston screw.	Mild detergent, warm water.	Sponge, cleaning cloth.	Mild detergent, warm water Sponge, cleaning cloth Remove contamination from the piston center screw using, if necessary, a brush to prevent the accumulation of waste.
Weekly.	Piston, piston seals and piston screw gasket	Mild detergent, warm water.	Sponge, cleaning cloth.	To remove the piston follow the instructions detailed above.
Every two weeks.	Machine body, bottom of the machine.	Mild detergent, warm water.	Sponge, cleaning cloth.	

NOTE: The above cleaning intervals are suggested for companies with just one work shift. The machine should be cleaned more frequently if it is used for multiple shifts each day.

STAINLESS STEEL CARE

NOTICE

Never use aggressive cleaners with stainless steel such as bleach or similar chlorine derivatives products. If you have used it, never leave acting, rinse immediately with plenty of water and dry thoroughly.

It is uncommon, but possible, that small traces of rust or oxidation points may be observed on the machine. This may be due to:

- Welding impurities.
- Food fragments adhering to the surface.
- Pits resulting from use of aggressive cleaners such as bleach or similar chlorine derivatives products.
- Moisture that remains after cleaning with water. ALWAYS wipe dry all components that have been cleaned. To remove these rust spots simply use a liquid stripper with a cloth, or clean with Scotch Brite.

MAINTENANCE

WARNING

- ALWAYS unplug the machine before proceeding with maintenance and inspection.
- ALWAYS follow the safety instructions in this manual during maintenance and inspection operations.

Breakdowns resulting from infrequent or improper maintenance can lead to expensive repairs, lost productivity due to down time and could void our warranty; therefore, regular and adequate maintenance is indispensable.

MAINTENANCE

The safety and life of the machine depend on many factors, including proper maintenance. Although it is difficult to give specific advice regarding inspection, maintenance or parts replacement schedules since these depend on many variables related to the machine's use, we can make some recommendations. The user, however, is solely responsible for formulating and following an inspection and maintenance schedules that reflect the machine's actual use. Our local distributor will be delighted to provide you with further information.

MAINTENANCE AND INSPECTION INTERVALS

Inspection interval	Critical component	Maintenance information
Daily.	Lid gasket.	Check it and replace it if necessary.
	Piston silicone seal.	Check it and replace it if necessary.
Monthly.	Knee lever.	Performance review and grease if necessary.
	Lid opening.	Performance review and grease if necessary.
Annually.	Hydraulic oil.	Check the level and fill the reservoir if necessary.
Every 2,500 to 5,000 hours.	Hydraulic oil.	Change the hydraulic oil.

NOTICE

The above maintenance and inspection intervals are suggested for a machine under normal use. The filler should be inspected and maintained more frequently if it is used heavily.

MAINTENANCE AND INSPECTION TIPS

⚠ WARNING

Electrical Hazard!

- If the electric cord becomes damaged, immediately have a qualified electrician replace it with a cord of identical specifications. Contact your dealer's service department to obtain the replacement cord.
- Lid gasket:
 - Replace in case of leakage of meat dough, in case of wear or breakage.
 - To reduce friction between the gasket and the bottom of the lid, lubricate both with animal or authorized fat.
 - It is manufactured of non-toxic material suitable for food use.
- Piston seal:
 - Replace if leakage or breakage.
 - To avoid noise when raising or lowering the piston, lubricate before inserting the piston into the tank with edible fat or other food authorized USDA
- Hydraulic: to avoid premature wear of the rod of the hydraulic reservoir, keep the piston at the bottom of the tank when finished using the machine. This way the rod will remain submerged in hydraulic oil.
- Lid closing: the lid can be closed more or less tightening the lid locking nuts, depending on the degree of sealing to be obtained. If you normally work with dry meat masses you can tighten the nuts with less force; for liquid masses you may close the lid more tightly and thus avoid the possibility of leakage.
- Spare parts: if you need a spare, contact your dealer who sold the unit, indicating all identification details

MAINTENANCE

(model, serial number, year of manufacture, power, voltage, frequency, etc.) you'll find on the nameplate of the machine.

HYDRAULIC OIL - AW32

- Hydraulic oil level:
 - Check the oil level on the marks of the tank. Unscrew and remove the screws that hold the panel to the machine base, then withdraw it.
 - On the tank, check that the oil level is between the MAX and MIN marks.
 - Fill the tank to the maximum level (not over), since the greater amount of cooling oil will improve dissipation of heat from the hydraulic unit, increasing its useful life.
 - The lack of oil for operation can be noticed if the piston rises "leapfrog" to allow air to enter the circuit.
- Oil temperature: given the pressure transmitted to pump hydraulic oil, it is normal that the temperature can rise up to 60° C and the machine body becomes hot after prolonged operating period. This machine is not designed to run in continuous, uninterrupted operation at high pressures, but to work in an intermittent regime with stops to dissipate generated heat.
- Hydraulic oil life: Trento cannot provide accurate data on the life of the oil, because it depends on several variable factors: temperature, operating pressure, presence of moisture or traces of water, etc. It can be estimated at 5,000 hours, depending on conditions. If the oil thins, is dirty and shows presence of impurities or after using the machine has a whitish color due to the presence of water, replace it by first emptying the oil deposit. Fill in oil following the instructions. Normally the hydraulic oil level will be maintained for years.
- Replacing the hydraulic oil:
 - It is recommended to remove used oil with a suction pump oil.
 - Unscrew and remove the screws that hold the panel to the machine base, then withdraw it.
 - Remove the depressurized oil cap (red) and enter the suction pipe of the pump through the same hole. Ensure that the tubing reaches the bottom of the tank to suck any impurities. Empty the tank by pumping the oil in a suitable container. Please recycle used oil.
 - Using a funnel or filling gun, enter the amount of hydraulic oil indicated in the table, through the filling hole. Do not fill the tank completely, as a certain volume of air is required for expansion of the warm oil.
 - Move the piston up and down two or three times in order to purge and remove air pockets circuit. The lack of enough oil for operation can be seen that the piston rises "leapfrog" to allow air to enter the circuit.
 - If an oil suction pump is not available, the oil reservoir can be disassembled by releasing the oil reservoir tubes and screws. Remove the tank and pour the oil through the filling hole into a suitable container.



Model	Oil reservoir capacity
F35	7 liters / 1.9 US Gal

Use high pressure hydraulic oil (200 bar) ISO VG 46 viscosity and quality level equivalent to ISO 6743-4: 2015 DIN 51524-2 or HM: 2006-04 HLP.

TROUBLESHOOTING

⚠ WARNING

- ALWAYS power off and unplug the machine from the electrical outlet before proceeding with cleaning, maintenance, or repairs.
- If you are unable to resolve the difficulty, DO NOT CONTINUE TO USE THE MACHINE and contact your authorized Trento dealer for service.

Problems	Possible Causes	Solutions
The machine is not working.	The machine is switched off.	Connect the machine.
	The machine is connected to a lower voltage.	Change the voltage of the machine to the right.
	Without tension in one or more stages.	Check fuses, plugs and switches.
	The internal micro switch on / off the knee lever is defective or not properly adjusted.	Contact an electrician to replace or readjusted.
The sound of the motor rotation is heard, but the piston does not go up or down when pushing the knee lever.	The pressure valve is at the minimum.	Increase pressure by turning knob clockwise.
	The motor turns in the opposite direction to the correct.	Permute two of the three phases in the plug.
The piston moves up and down but the machine seems to lack strength.	The air passage hole located at the base of the tank is clogged.	Clean it.
	The piston and the piston seal are dirty.	Clean them.
	The mains voltage is not compatible with the selected for the engine.	Contact an electrician to change the voltage of the machine.
	The three-phase motor (if applicable) is only running two phases.	Contact an electrician to check electric grid.
	There is little hydraulic oil.	Fill the oil reservoir up to "MAX"
	There is an oil leak in the fittings or pipes.	Call your local dealer.
	The chambers of the hydraulic cylinder are communicated.	Call your local dealer.

PARTS BREAKDOWN

ITEM	MODEL
46325	SS-ES-0065-C

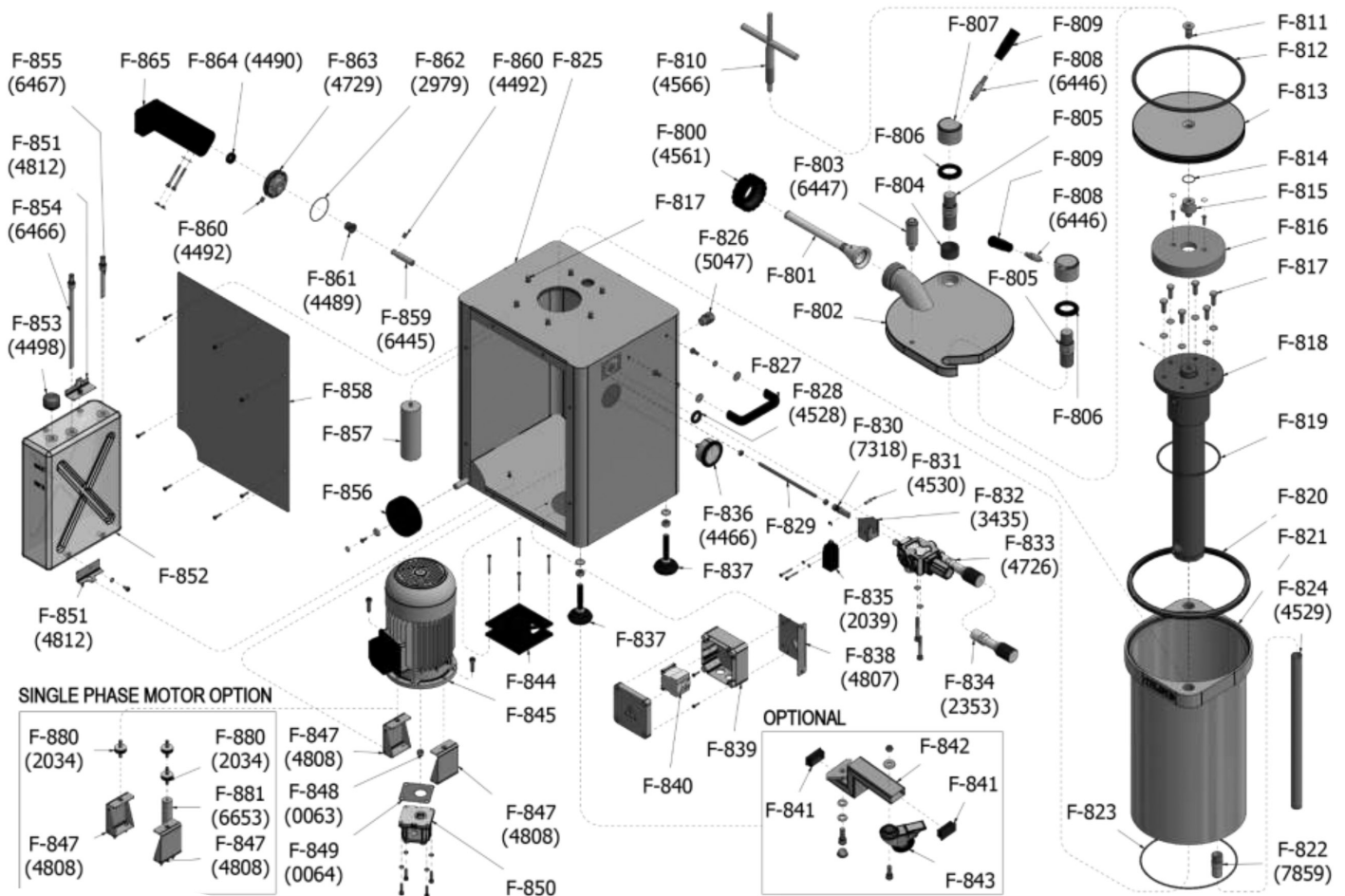

PARTS BREAKDOWN

ITEM	MODEL
46325	SS-ES-0065-C

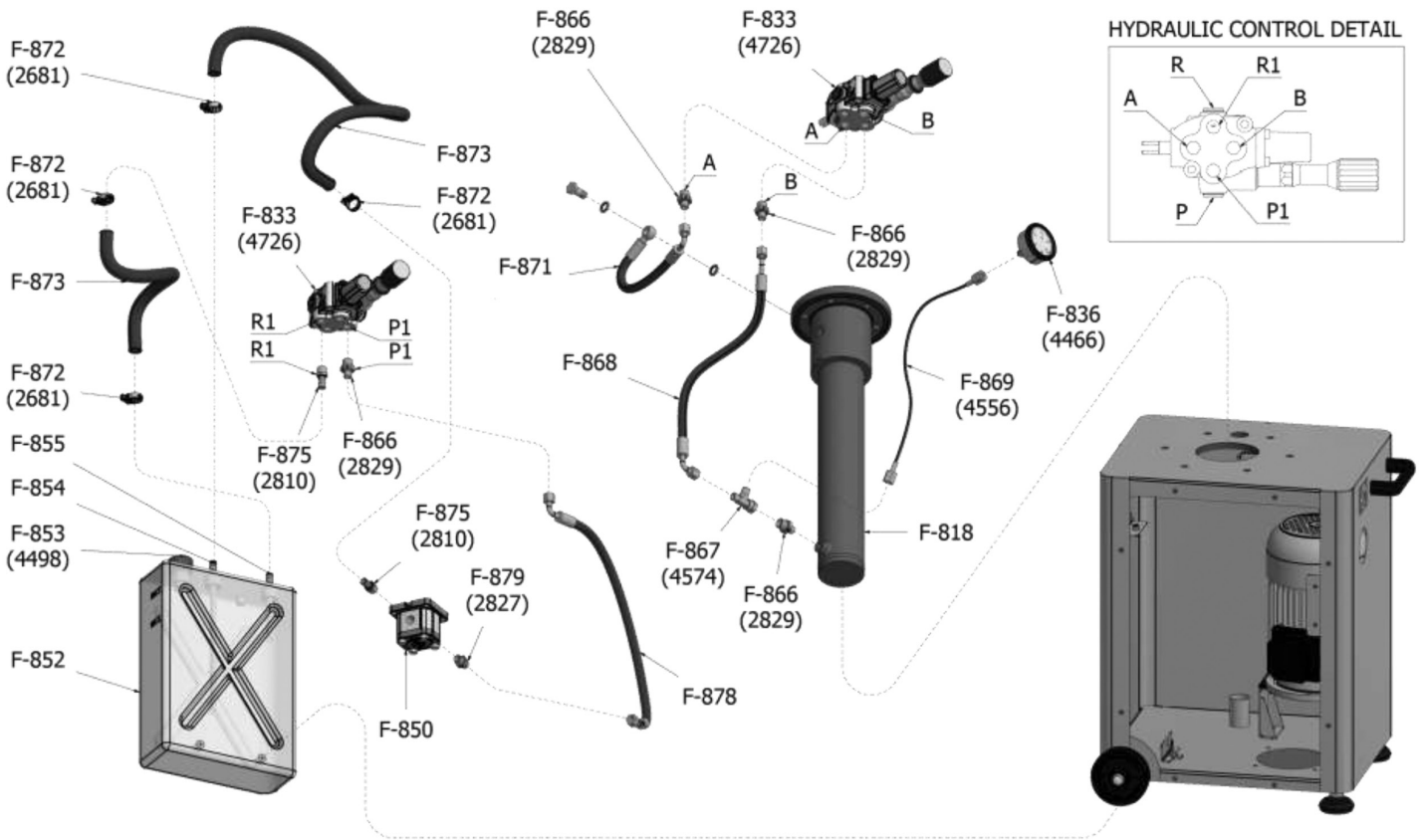

PARTS BREAKDOWN

ITEM	MODEL
46325	SS-ES-0065-C

Item No.	Description	Position	Item No.	Description	Position	Item No.	Description	Position
AC922	Locking Nut for Curved Nozzle and HF1, Open, Stainless Steel for 46325	F-800	AD193	Hydraulic Cylinder for 46325	F-818	66878	Pressure Gauge D.63, WIKA 213.53, 0-200 Bar, Thread 1-4" for 46325	F-836
16508	Nozzle/Horn All Stainless Steel Short Ext. Diam.20/Int.17 L.Use.195mm (7.5) Tube for 46325	F-801	66918	O-Ring, Hydraulic Cylinder for 46325	F-819	66879	Foot, Stainless Steel for 46325	F-837
66927	Stainless Steel Lid, without Accessories for 46325	F-802	66930	Lid Seal Polyurethane Red for 46325	F-820	66880	Holder Isolating Box for 46325	F-838
66847	Lid Opening Lever AISI303 for 46325	F-803	66931	Fixed Dough Barrel for 46325	F-821	36042	Isolating Box, Legrand 100x100x55mm Code 92138 for 46325	F-839
66848	Bras Bushing B11 Lid for 46325	F-804	66866	Deposit Drainage Pipe D.27 L.62 Gas 3/4" AISI304 for 46325	F-822	66048	Isolating Box, IDE 162x116x76, Polycarbonate (H UL-CSA +110V) for 46325	F-839
66849	Stainless Steel Bolt, Lid for 46325	F-805	66932	O-Ring, Flange Dough Barrel for 46325	F-823	44093	Contacter 6A 208V/60HZ/3 for 46325	F-840
AD191	Washer for Lid Lock Nut, Bronze B7 for 46325	F-806	66868	Transparent Fabric Hose PVC D.32x25, Deposit Drain for 46325	F-824	66881	Cap, KAPSTO, GPN270, Swivel Castors for 46325	F-841
66851	Nut for Lid Lock AISI303 for 46325	F-807	66922	Cabinet with Accessories for 46325	F-825	66882	Extension Swivel Castor AISI304 for 46325	F-842
66852	Lever for Lid Lock Nut AISI303, without Black Knob for 46325	F-808	66870	Grommet, S-TEC 5308959 M20x1,5/13 Poliamyde, Grey for 46325	F-826	69577	Castors with Brake and Leg Stainless Steel 2 PCS per Set for 46325	F-843
66853	Knob Black Thread M10 80mm for 46325	F-809	66923	Handle M8 for 46325	F-827	66884	Fan, 120x120x38 110V 50/60Hz 1-Phase 156 M3/H 115V UL/CSA for 46325	F-844
66854	Spanner/Wrench, Piston Extractor for 46325	F-810	66872	Wall Pass-Through D.34/21,8x6mm EPDM Black 70 SH for 46325	F-828	39059	Air Extraction Fan 220V 1PH for 46325	F-844
66855	CSK Allen Screw, Stainless Steel DIN7991 for 46325	F-811	66924	Threaded Rod Hydraulic Control M8 AISI30 for 46325	F-829	19410	Motor H26 3-Phase H 3/208/220V-60HZ-1.5HP-1.1KW 1700 RPM for 46325	F-845
66928	Piston Gasket, O-Ring, Red Silicone (1*Piston) for 46325	F-812	19415	Internal Fork, Hydraulic Control Activator, Stainless Steel for 46325	F-830	66886	Silent Block Single Phase Motor 70x30x5mm EPDM Black for 46325	F-846
66929	Piston, Stainless Steel, without O-Ring for 46325	F-813	66875	Cylindrical Pin, D.6x19,5 Stainless Steel for 46325	F-831	66887	Motor Mounting Bracket for 46325	F-847
66914	O-Ring, Threaded Tip Piston for 46325	F-814	36037	Hydraulic Control Micro Switch Holder from 02/02 for 46325	F-832	31222	Motor-Pump Coupling for Fillers/ Stuffers for 46325	F-848
66915	Threaded Tip Hydraulic Cylinder Bolt AISI303 for 46325	F-815	66877	Hydraulic Control 102N8SA23X-340 with Pressure Knob for 46325	F-833	31221	Seal, Vellumoid 1625-1 for Pump Type L for 46325	F-849
66916	Hood Clamp, Hydraulic Cylinder, Grey for 46325	F-816	31219	External Pressure Valve Control Assembly M1670/861, Black Knob for 46325	F-834	36028	Gear Pump H223 for 46325	F-850
66861	Stainless Steel Hexagonal Screw for 46325	F-817	16524	Micro Position Detector, Comepi Metal Wheel for 46325	F-835	66889	Support Oil Reservoir/Cabinet for 46325	F-851

PARTS BREAKDOWN

ITEM	MODEL
46325	SS-ES-0065-C

Item No.	Description	Position	Item No.	Description	Position	Item No.	Description	Position
66890	Internal Oil Reservoir, Poliprop. White for 46325	F-852	66898	O-Ring, Int. Diam. 61x2 for 46325	F-862	66908	Hose Clamp, MIKALOR D.12-20/9 for Hydr. Oil Drain Tube NH for 46325	F-872
66891	Oil Cap, Depressurized, Red for 46325	F-853	66899	Support Knee Lever AISI304 for 46325	F-863	66909	Rubber Hose KLEMINE-20 Bar D.12x20 for 46325	F-873
66892	Oil Return Pipe D.10 L.120mm for 46325	F-854	66900	Gasket, Knee Lever for 46325	F-864	61763	Nozzle Cover, Rubber 12 Male Thread 3/8" (Draining Hose) for 46325	F-875
66893	Oil Suction Pipe D.10 L.270mm for 46325	F-855	AF861	Knee Lever Black for 46325	F-865	66910	Hose, R1T1/4 TL90HG8L-TL45HG8L (Hydraulic Pump Control) for 46325	F-878
36110	Wheel, Nylon H214 for 46325	F-856	66902	Hydraulic Union, Simple, GE8LR 3/8" BSP for 46325	F-866	65038	Hydraulic Union, Simple, GE8LR 1/4" BSP for 46325	F-879
66926	Panel Access Cabinet for 46325	F-858	66903	T Joint EVL-08 (Outlet Control to Hydraulic Cylinder + Gauge) for 46325	F-867	AC974	Washer, Stainless Steel, Straight D.6,4-M6 DIN125 for 46325	
66895	Activator Knee Lever D.15 L.70mm AISI303 for 46325	F-859	66904	Hose, R1T1/4 TL90HG8L-TL45HG8L, Bottom Cylin-Hydr Control for 46325	F-868	AC973	Allen Screw, Stainless Steel M6x55 DIN912 for 46325	
66896	Pedal Brass Bushing, B11 A-6-9-12 for 46325	F-860	66905	Hose, Pressure Gauge 1/4", Length 500mm for 46325	F-869			
66897	Brass Bushing, B11 B-15-20-20/25-3 with Collar for 46325	F-861	66907	Hose, 290mm R1T1/4 ESF1/4-TL90HG8L, Top Cylin-Hydraulic Control for 46325	F-871			

ELECTRICAL SCHEMATICS

ITEM	MODEL
46325	SS-ES-0065-C

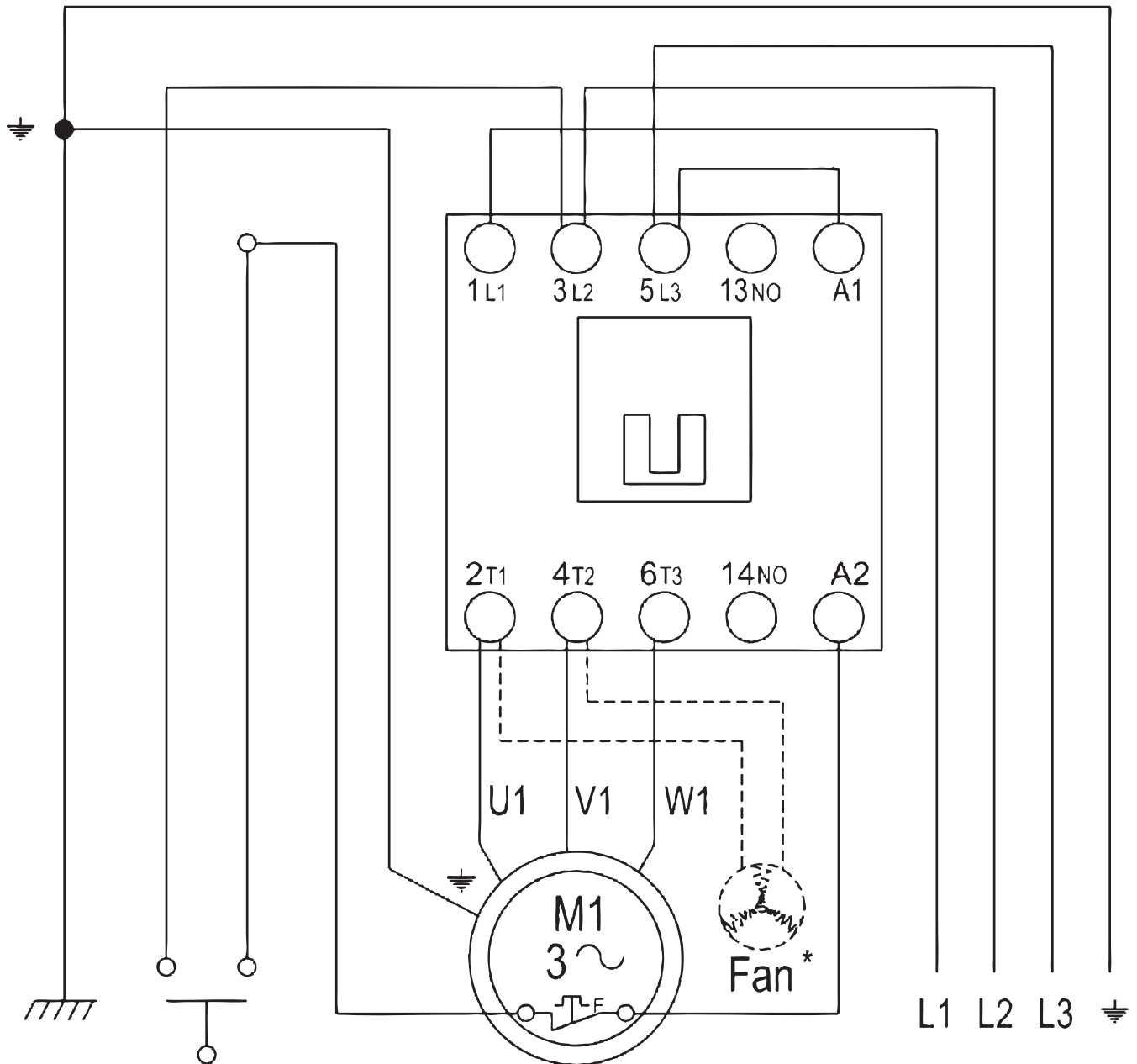

Motor with internal thermo protection

* Fan only in F50 stuffers.

WARRANTY REGISTRATION

Thank you for purchasing an Trento product. To register your warranty for this product, complete the information below, tear off the card at the perforation and then send to the address specified below. You can also register online by visiting:

Merci d'avoir acheté un produit Trento. Pour enregistrer votre garantie pour ce produit, complétez les informations ci-dessous, détachez la carte au niveau de la perforation, puis l'envoyer à l'adresse spécifiée ci-dessous. Vous pouvez également vous inscrire en ligne en visitant:

Gracias por comprar un producto Trento usted. Para registrar su garantía para este producto, complete la información a continuación, cortar la tarjeta en la perforación y luego enviarlo a la dirección indicada a continuación. También puede registrarse en línea en:

<https://omcan.com/warranty-registration/>

For mailing in Canada

Pour postale au Canada

Por correo en Canadá

TRENTO

PRODUCT WARRANTY REGISTRATION

3115 Pepper Mill Court,
Mississauga, Ontario
Canada, L5L 4X5

For mailing in the US

Pour diffusion aux États-Unis

Por correo en los EE.UU.

TRENTO

PRODUCT WARRANTY REGISTRATION

4450 Witmer Industrial Estates, Unit 4,
Niagara Falls, New York
USA, 14305

or email to: trentoservice@trentoequipment.com



Purchaser's Information

Name: _____ Company Name: _____

Address: _____ Telephone: _____

City: _____ Province or State: _____ Postal or Zip: _____ Email Address: _____

Country: _____ Type of Company: _____

Dealer from which Purchased: _____ Restaurant Bakery Deli

Dealer City: _____ Dealer Province or State: _____ Butcher Supermarket Caterer

Invoice: _____ Institution (specify): _____

Model Name: _____ Model Number: _____ Serial Number: _____

Machine Description: _____

Date of Purchase (MM/DD/YYYY): _____ Date of Installation (MM/DD/YYYY): _____

Would you like to extend the warranty? Yes No

Thank you for choosing Trento | Merci d'avoir choisi Trento | Gracias por elegir Trento

TRENTO

ELEVATING CULINARY EXCELLENCE

TRENTO IS A SIGNATURE LINE OF PROFESSIONAL RESTAURANT EQUIPMENT FROM OMCAN OFFERING PREMIUM EUROPEAN BRANDS TO THE NORTH AMERICAN MARKET.

Thank you for your purchase!



Follow us on social media
@trentoequipment

